

JAKEMY®



2024

JAKEMY DIY TOOL SERIES

- ELECTRONICS REPAIR
- INTELLIGENT HOUSEHOLD DISASSEMBLY

GZ YI FENG TECHNOLOGY ELECTRON CO.,LTD

COMPANY PROFILE

GZ Yifeng Technology Electron CO.,LTD is developed from Guangzhou Wan Feng Electronics Company which was established in 1998. It is a modern company including research developments, manufacturing and customer services. Our factory specializes in manufacturing and exporting all kinds of hand tools and outdoor tools. We also have more than 15 years of leading experience in manufacturing and exporting business and professional production equipment, we can provide customer with OEM&ODM services. We have established cooperation with different channels of customers including supermarket and famous international electronic commerce companies, we can offer the products analysis and various styles of item pictures to our customer. We have a wide range of product line, meeting all kinds of DIY repairing needs. We have been developing different types of products according to the changing marketing demands. Besides we have the International Registration of Trade Marks, Product design patents and various test certifications.

BRANDS

Our main brands are **JACKLY**[®], **JAKEMY**[®]. The products are popular throughout Asia, Europe, Africa and South America. They are famous for the perfect quality and reasonable price. We will focus on researching and developing new products, keeping high quality as our major mission. We will be greatly appreciated that if you share some opinions with us.

GLOBAL TRADEMARK REGISTRATION CERTIFICATE



OUR HISTORY OF GROWTH

- 2016 ~ Now:** We have been expanding the global business and growth strategy.
- 2015:** Our new product line-Project J of JAEKMY launch into the market in 2015.
- 2013:** Our passion for keeping high quality has been seen around the world with our disciplined operations, rapid business growth, and loyal customer relationships.
- 2012:** Participated in different types of hardware exhibition shows. Sales record has increased twice as much as the prior year and more and more regular customers continued to re-order our products because of our guaranteed high quality.
- 2011:** Most of our products meet the standard of CE and RoHS.
- 2010:** Foreign trading department was officially established and created a professional page through an international trading platform.
- 2009:** Created our first official website.
- 2007:** Transformed from traditional business into e-business.
- 1998:** Company Established.

2024 NEW ARRIVAL

35PCS

ELECTRIC SCREWDRIVER SET

H4*28MM:

⊕ 1.5 2.0 3.0 ⊖ 1.5 2.0 3.0 ⊕ 0.8 1.2 1.5

⊕ T2 T3 T4 ⊖ Y0.8 Y2.0 ⊕ YP4.5

⊕ 2.3 ⊕ U1.7 ⊕ 1.5

H6.3*25MM:

⊕ T8H T9H T10H ⊕ H3 H4 H5 H6 ⊕ 4.0 5.0

⊖ 4.0 5.0 ⊖ Y1

Accessories:

Manual screwdriver handle(with scale)*1

Magnetizer*1

Charging Cable*1

Strap for electric screwdriver*1

Electric torque:

1ST GEAR

TORQUE 1.9-3.0 kgf.cm (0.19-0.30 N.m) SPEED 130-135 RPM

2ND GEAR

TORQUE 4.5-5.8 kgf.cm (0.45-0.58 N.m) SPEED 140-145 RPM

3RD GEAR

TORQUE 6.5-7.5 kgf.cm (0.65-0.75 N.m) SPEED 154-158 RPM

4TH GEAR

TORQUE 7.6-10 kgf.cm (0.76-1 N.m) SPEED 163-165 RPM



Press and hold for 3 sec
to enter lighting mode



Quickly double-tap to
enter SOS mode



Double-tap again to
enter strobe mode



JM-8196

180 IN 1 ELECTRIC SCREWDRIVER KIT

180PCS

Socket:

⊙ M2.5 M3.0 M3.5 M4.0 M4.5 M5.0 M5.5 G3.8 G4.5 ü PH2 OVAL

H4*45MM:

⊕ 1.5 2.0 ⊖ 1.5 2.0

H4*28MM:

⊙ T1*3 T2*3 T3*2 T4*2 T5 T6 T7 T8 T9 T10 T15 T20 T6H T7H T8H T9H T10H T15H T20H T25H

⊙ H0.7*2 H0.9*2 H1.3 H1.5 H2.0 H2.5 H3.0 H3.5 H4.0 H4.5 H5.0 H6.0

⊕ 1.0*2 1.5*3 2.0*2 2.5*2 3.0*3 3.5*2 JIS000 JIS00 JIS0 JIS1

⊙ SIM0.8 SIM1.0 ⊙ 4.5 ⊙ PRY ⊙ AWL ⊙ 1.5*2

⊖ 1.0*2 1.3*2 1.5*2 2.0*2 2.5*2 3.0*2 3.5*2 4.0*2 4.5 5.0

⊙ 1/16 1/8 3/32 5/32 5/64 7/64 9/64

⊙ Y0.8*3 Y2.0*2 Y2.5*2 Y3.0*2 Y3.5*2

⊙ U1.7 U2.0*2 U2.6*2 U3 U8 U10

⊙ 0.8*3 1.2*3 1.5*3 2.0*2

⊕ PZ00 PZ0 PZ1 PZ2

⊕ SQ0 SQ1 SQ2 SQ3

⊕ 2.0 2.3 2.6 3.0 ⊕ IN PH2*2

⊕ EX#6 EX#7 EX#8 EX#9 EX#10

⊕ DR#6 DR#7 DR#8 DR#9 DR#10

H4.0mm to H6.3mm socket

H6.3mm to H4.0mm socket

[⊏] + [⊐]

Accessories:

Opening tool*5 Ultra-thin opening tool*5

Built-in magnetizer*1 Suction cup*1

Spudger*2 Extension rod*1

Creative handle*1 Tweezers*2

Charging cable*1

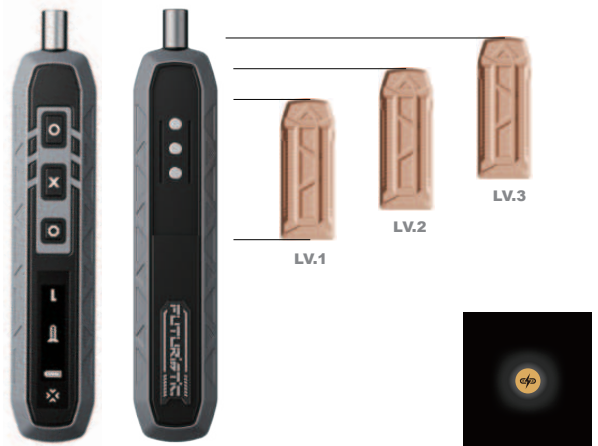
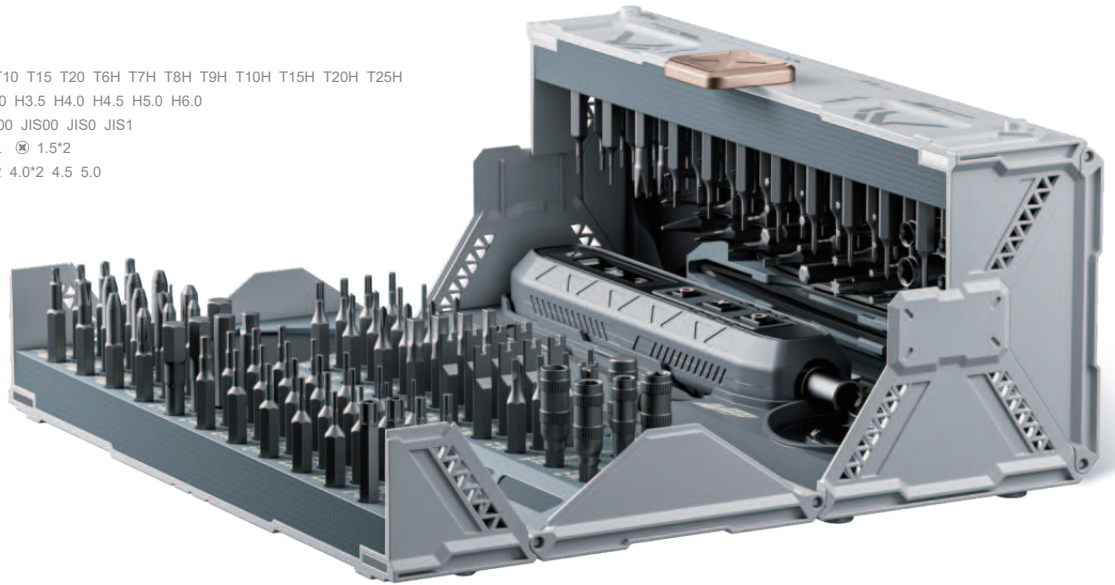

JM-8193

180 IN 1 SCREWDRIVER KIT

180PCS

Socket:

⊙ M2.5 M3.0 M3.5 M4.0 M4.5 M5.0 M5.5 G3.8 G4.5 ü PH2 OVAL

H4*45MM:

⊕ 1.5 2.0 ⊖ 1.5 2.0

H4*28MM:

⊙ T1*3 T2*3 T3*2 T4*2 T5 T6 T7 T8 T9 T10 T15 T20 T6H T7H T8H T9H T10H T15H T20H T25H

⊙ H0.7*2 H0.9*2 H1.3 H1.5 H2.0 H2.5 H3.0 H3.5 H4.0 H4.5 H5.0 H6.0

⊕ 1.0*2 1.5*3 2.0*2 2.5*2 3.0*3 3.5*2 JIS000 JIS00 JIS0 JIS1

⊙ SIM0.8 SIM1.0 ⊙ 4.5 ⊙ PRY ⊙ AWL ⊙ 1.5*2

⊖ 1.0*2 1.3*2 1.5*2 2.0*2 2.5*2 3.0*2 3.5*2 4.0*2 4.5 5.0

⊙ 1/16 1/8 3/32 5/32 5/64 7/64 9/64

⊕ Y0.8*3 Y2.0*2 Y2.5*2 Y3.0*2 Y3.5*2

⊕ U1.7 U2.0*2 U2.6*2 U3 U8 U10

⊙ 0.8*3 1.2*3 1.5*3 2.0*2

⊕ PZ00 PZ0 PZ1 PZ2

⊕ SQ0 SQ1 SQ2 SQ3

⊕ 2.0 2.3 2.6 3.0 ⊕ IN PH2*2

⊕ EX#6 EX#7 EX#8 EX#9 EX#10

⊕ DR#6 DR#7 DR#8 DR#9 DR#10

H4.0mm to H6.3mm socket

H6.3mm to H4.0mm socket

[] + []

Accessories:

Opening tool*5 Ultra-thin opening tool*5

Built-in magnetizer*1 Suction cup*1

Spudger*2 Extension rod*1

Creative handle*1 Tweezers*2

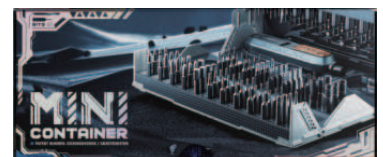
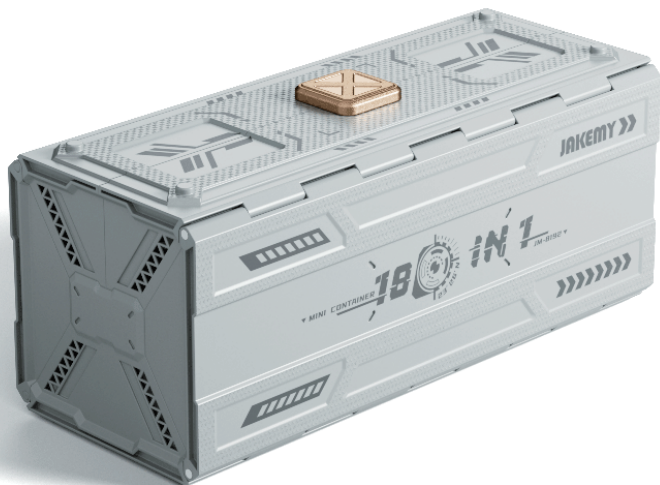
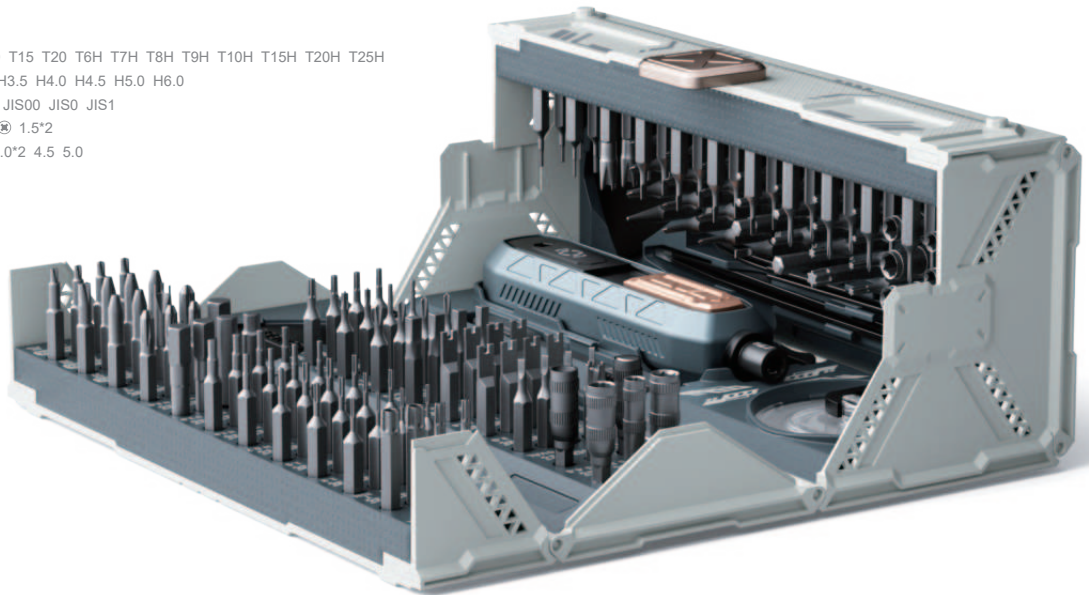

JM-8192

SQUARE HANDLE DESIGN SCREWDRIVER

21PCS

H4*33MM:

⊕ 1.0 1.5 3.0 3.5 ⊖ 1.0 1.5 ⊕ Y0.8 Y2.0 ⊖ U1.7 U2.0
⊕ T2 T6 T8 T10 ⊕ 0.8 1.2 ⊕ H1.5 ⊕ 2.0 2.3 ⊕ 1.5

Color option:

Dark black

Noble Purple



JM-8195

Screwdriver set

25PCS

H4*28MM:

⊕ T1 T2 T3 T4 T5 T6H T7H ⊕ H1.5 H2.0 H2.5
⊕ 1.5 3.0 3.5 ⊕ Y0.8 Y2.0 ⊖ 1.5 2.0 2.5
⊕ 0.8 1.2 ⊕ 2.3 ⊕ 1.5

Accessories:

Big size shelf blocks*2 Medium size shelf blocks*12(black color) Handle*1
Medium size shelf blocks*12(white color) Small size shelf blocks*12(black color)
Small size shelf blocks*12(white color)



JM-8185

Screwdriver set

83PCS

Sockets:

M2.5 M3.0 M3.5 M4.0 M4.5 M5.0 M5.5 G3.8 G4.5 U8 U10 PH2 ⊖

H4*28MM:

⊕ H0.9 H1.3 H1.5 H2.0 H2.5 H3.0 H3.5 H4.0 H4.5 H5.0 H6.0 ⊕ Y0.8 Y2.0 Y2.5 Y3.0
⊕ T1 T2 T3 T4 T5 T6H T7H T8H T9H T10H T15H T20H T25H ⊕ SQ1 SQ2 SQ3
⊖ 1.0 1.5 2.0 2.5 3.0 3.5 4.5 5.0 ⊕ 1.0 1.5 2.0 2.5 3.0 3.5 ⊕ 2.3 ⊕ 1.5
⊕ 0.8 1.2 1.5 2.0 ⊕ YP4.5

H6.3*25MM: H4*45MM:

⊖ 6.0 7.0 ⊕ 6.0 6.5 ⊖ 1.5 2.0 ⊕ 1.5 2.0

Accessories:

Spudger*2 Sockets H4 to H6.3*1

Ultra thin opening tools*3

Magnetizer ring*1

Suction cup*1

Tweezers*1

Manual*1

Handle*1



JM-8186A

Screwdriver set

83PCS

Sockets:

M2.5 M3.0 M3.5 M4.0 M4.5 M5.0 M5.5 G3.8 G4.5 U8 U10 PH2 ⊖

H4*28MM:

⊕ H0.9 H1.3 H1.5 H2.0 H2.5 H3.0 H3.5 H4.0 H4.5 H5.0 H6.0 ⊕ Y0.8 Y2.0 Y2.5 Y3.0
⊕ T1 T2 T3 T4 T5 T6H T7H T8H T9H T10H T15H T20H T25H ⊕ SQ1 SQ2 SQ3
⊖ 1.0 1.5 2.0 2.5 3.0 3.5 4.5 5.0 ⊕ 1.0 1.5 2.0 2.5 3.0 3.5 ⊕ 2.3 ⊕ 1.5
⊕ 0.8 1.2 1.5 2.0 ⊕ YP4.5

H6.3*25MM: H4*45MM:

⊖ 6.0 7.0 ⊕ 6.0 6.5 ⊖ 1.5 2.0 ⊕ 1.5 2.0

Accessories:

Spudger*2 Sockets H4 to H6.3*1

Ultra thin opening tools*3

Magnetizer ring*1

Suction cup*1

Tweezers*1

Manual*1

Handle*1

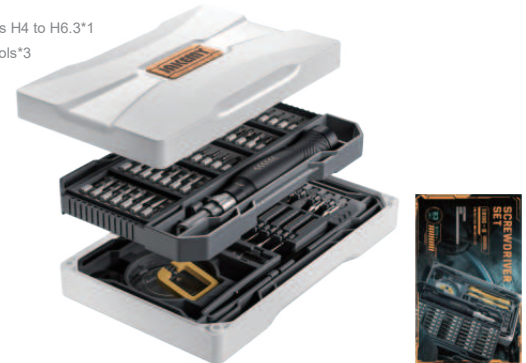

JM-8186B

Screwdriver set

83PCS

Sockets:

M2.5 M3.0 M3.5 M4.0 M4.5 M5.0 M5.5 G3.8 G4.5 U8 U10 PH2 0

H4*28MM:

⊙ H0.9 H1.3 H1.5 H2.0 H2.5 H3.0 H3.5 H4.0 H4.5 H5.0 H6.0 ⊙ Y0.8 Y2.0 Y2.5 Y3.0

⊙ T1 T2 T3 T4 T5 T6H T7H T8H T9H T10H T16H T20H T25H ⊙ SQ1 SQ2 SQ3

⊙ 1.0 1.5 2.0 2.5 3.0 3.5 4.5 5.0 ⊕ 1.0 1.5 2.0 2.5 3.0 3.5 ⊕ 2.3 ⊗ 1.5

⊕ 0.8 1.2 1.5 2.0 ⊕ YP4.5

H6.3*25MM:

H4*45MM:

⊖ 6.0 7.0 ⊕ 6.0 6.5 ⊖ 1.5 2.0 ⊕ 1.5 2.0

Accessories:

Spudger*2 Sockets H4 to H6.3*1

Ultra thin opening tools*3

Magnetizer ring*1

Suction cup*1

Tweezers*1

Manual*1

Handle*1



JM-8187

Screwdriver set

32PCS

H4*28MM:

⊙ H1.5 H2.0 H3.0 H4.0 ⊙ T1 T2 T4 T6H T8H T10H T15H

⊕ 1.0 1.5*2 2.0 2.5 ⊖ 1.5*2 2.0 2.5*2 ⊕ 2.0 3.0

⊙ 0.8 ⊕ U2.6 ⊗ 1.5 ⊙ Y0.8 Y2.0 Y2.5 Y3.0

Accessories:

Tweezers*1

Handle*1



JM-8189A

Precision screwdriver set

32PCS

H4*28MM:

⊙ H1.5 H2.0 H3.0 H4.0 ⊙ T1 T2 T4 T6H T8H T10H T15H

⊕ 1.0 1.5*2 2.0 2.5 ⊖ 1.5*2 2.0 2.5*2 ⊕ 2.0 3.0

⊙ 0.8 ⊕ U2.6 ⊗ 1.5 ⊙ Y0.8 Y2.0 Y2.5 Y3.0

Accessories:

Tweezers*1

Handle*1



JM-8189B

Precision screwdriver set

32PCS

H4*28MM:

⊙ H1.5 H2.0 H3.0 H4.0 ⊙ T1 T2 T4 T6H T8H T10H T15H

⊕ 1.0 1.5*2 2.0 2.5 ⊖ 1.5*2 2.0 2.5*2 ⊕ 2.0 3.0

⊙ 0.8 ⊕ U2.6 ⊗ 1.5 ⊙ Y0.8 Y2.0 Y2.5 Y3.0

Accessories:

Extension bar*1

Handle*1



JM-8189C

Light weight aluminum alloy screwdriver

⊕ 0.8 ⊕ 1.5 ⊖ Y0.8 ⊕ T1 ⊗ 1.5

Accessories:

External magnetic ring*1



*The above is a single screwdriver.

JM-8190



Precision screwdriver set

47PCS

Sockets:

M2.5 M5.0 G3.8 G4.5

H4*28MM:

⊕ T1 T2 T3 T4 T5 T6 T8 T10 T15 ⊖ 1.0 1.5 2.0 2.5 3.0 3.5 4.0

⊕ 1.0 1.5 2.0 2.5 3.0 3.5 ⊗ H0.9 H1.5 H2.5 H3.0 ⊕ Pz1 Pz2

⊖ Y0.8 Y2.0 Y2.5 Y3.0 ⊕ 0.8 1.2 1.5 2.0

⊕ 2.0 3.0 ⊗ 1.5 ⊕ 0.8

Accessories:

Soft extension bar*1 Strong adsorption magnetic mat*1

Manual*1 Handle*1



JM-8180 T0 A

Precision screwdriver set

47PCS

Sockets:

M2.5 M5.0 G3.8 G4.5

H4*28MM:

⊕ T1 T2 T3 T4 T5 T6 T8 T10 T15 ⊖ 1.0 1.5 2.0 2.5 3.0 3.5 4.0

⊕ 1.0 1.5 2.0 2.5 3.0 3.5 ⊗ H0.9 H1.5 H2.5 H3.0 ⊕ Pz1 Pz2

⊖ Y0.8 Y2.0 Y2.5 Y3.0 ⊕ 0.8 1.2 1.5 2.0

⊕ 2.0 3.0 ⊗ 1.5 ⊕ 0.8

Accessories:

Soft extension bar*1 Strong adsorption magnetic mat*1

Manual*1 Handle*1



JM-8180 T0 B

Precision screwdriver set

47PCS

Sockets:

M2.5 M5.0 G3.8 G4.5

H4*28MM:

⊕ T1 T2 T3 T4 T5 T6 T8 T10 T15 ⊖ 1.0 1.5 2.0 2.5 3.0 3.5 4.0

⊕ 1.0 1.5 2.0 2.5 3.0 3.5 ⊗ H0.9 H1.5 H2.5 H3.0 ⊕ Pz1 Pz2

⊖ Y0.8 Y2.0 Y2.5 Y3.0 ⊕ 0.8 1.2 1.5 2.0

⊕ 2.0 3.0 ⊗ 1.5 ⊕ 0.8

Accessories:

Soft extension bar*1 Felt bag*1

Manual*1 Handle*1



JM-8184

Dual dynamics precision electric screwdriver

8PCS

H4*28MM:

⊕ 0.8 1.2 ⊕ 1.5 ⊖ Y0.8 ⊕ T2 ⊗ 1.5

Accessories:

Magnetizer*1 TYPE-C Cord*1 Manual*1



JM-Y05

Dual dynamics precision electric screwdriver

41PCS

H4*28MM:

⊕ T2 T3 T4 T5 T6H T7H T8H T9H T10H T15H T20H

⊕ H1.3 H1.5 H2.0 H2.5 H3.0 H3.5

⊖ 1.5 2.0 2.5 3.0 3.5 4.0

⊖ Y0.8 Y2.0 Y2.5 Y3.0

⊕ 1.5 2.0 2.5 3.0 3.5

⊕ 0.8 1.2 1.5 2.0

⊕ 2.0 3.0

⊖ U2.6

⊗ 1.5

Accessories:

Charger*1



JM-Y03 PLUS

Dual dynamics precision electric screwdriver

22PCS

H4*28MM:

⊕ T2 T3 T4 T5 T6H T7H T8H T9H

⊖ 1.5 2.0 2.5 3.0

⊕ 1.5 2.0 2.5 3.0

⊖ Y0.8 Y2.0

⊕ 0.8 1.2

⊗ 1.5

Accessories:

Magnetic mat*1

Charger*1

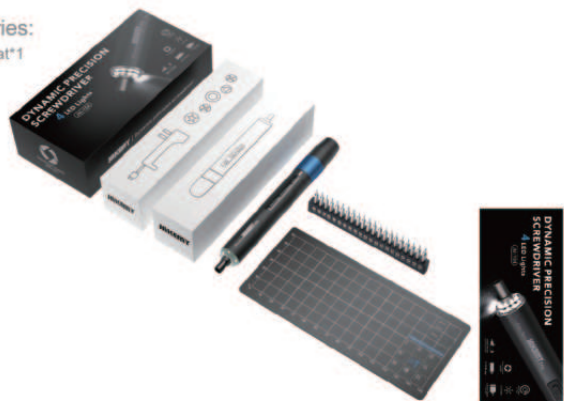

JM-Y04

PRECISE ELECTRIC SCREWDRIVER PEN

2PCS

Accessories:

TYPE-C Cord*1

Handle*1



JM-Y07

Pro tech tool kit

201PCS

Sockets: M2.5 M3.0 M3.5 M4.0 M4.5 M5.0 M5.5 G3.8 G4.5
H4*28MM:

⊙ H0.7*2 H0.9*2 H1.3*2 H1.5*2 H2.0 H2.5 H3.0 H3.5 H4.0 H4.5 H5.0 H6.0 ⊕ U2.6*2 U3.0
⊙ T1*2 T2*2 T3*2 T4*2 T5*2 T6 T7 T8 T9 T10 T15 T20 ⊕ 2.0*2 2.3*2 2.6 3.0
⊙ T6H T7H T8H T9H T10H T15H T20H ⊕ 0.8*5 1.2*2 1.5*2 2.0*2 ⊕ SIM0.8 SIM1.0
⊕ 1.0*2 1.5*2 2.0*2 2.5*2 3.5*2 4.0*2 JIS000 JIS00 JIS0 JIS1 ⊕ SQ0 SQ1 SQ2
⊖ 1.0*2 1.3*2 1.5*2 2.0*2 2.5*2 3.0*2 3.5*2 4.0*2 ⊕ PZ1.0*2 PZ2.0*2 PZ3.0*2 PZ4.0*1
Dr #2 #3 #4 #5 ⊖ Y0.8*2 Y2.0*2 Y2.5*2 Y3.0*2

H6.3*25MM:

⊙ T8H T9H T10H T15H T20H T25H*2 T30H*2
⊙ H2.5 H3.0 H4.0 H5.0 H6.0 ⊕ U6 U8
⊖ 3.0 4.0 5.0*2 6.0*2 7.0*2 ⊕ R1
⊕ 4.0*2 5.0*2 6.0*2 6.5*2
⊖ Y1.0*2 Y2.0*2 Y3.0*2
⊙ T4 T5 T6 T7 ⊕ 2.3
⊕ PZ1.0 PZ2.0 PZ3.0

ADP: H6.3 to H4

Accessories:

Small shovel-shape spudger*1
Double-end spudger*1
Double-sided plush glasses cloth*1
Straight metal spudger*1
Soft extension bar*1
Extension rod*1
Medium handle*1
Big handle*1
Magnetic mat*1
Big suction cup with key ring*1

Brush*1
Spudger*1
Tweezers*1
Magnetizer*1
Thin triangular slice*12



YF-P13

Pet electric shaver

Accessories:

With limiting comb*8(3/6/10/13/16/19/22/25mm)
Ceramic shaver head*1
Charging base*1(optional)
Charging cable*1
Hair clipper*1
Manual*1
Lubricant*1
Brush*1



JM-PE02

Intell automatic drip irrigation kit

Accessories:

Rubber hose*1
Cross pipe*1
T-pipe*1
TYPE-C Cord*1

10 Plants version
15 Plants version



JM-G01

Pro tech tool kit

141PCS

Sockets:

M2.5 M3.0 M3.5 M4.0 M4.5 M5.0 M5.5 G3.8 G4.5

H4*28MM:

⊙ H0.7*2 H0.9*2 H1.3*2 H1.5*2 H2.0 H2.5 H3.0 H3.5 H4.0 H4.5 H5.0 H6.0 ⊕ U2.6*2 U3.0
⊙ T1*2 T2*2 T3*2 T4*2 T5*2 T6 T7 T8 T9 T10 T15 T20 ⊕ 2.0*2 2.3*2 2.6 3.0 ⊕ 1.5*2
⊙ T6H T7H T8H T9H T10H T15H T20H ⊕ 0.8*5 1.2*2 1.5*2 2.0*2 ⊕ SIM0.8 SIM1.0
⊕ 1.0*2 1.5*2 2.0*2 2.5*2 3.5*2 4.0*2 JIS000 JIS00 JIS0 JIS1 ⊕ SQ0 SQ1 SQ2
⊖ 1.0*2 1.3*2 1.5*2 2.0*2 2.5*2 3.0*2 3.5*2 4.0*2 ⊕ PZ1.0*2 PZ2.0*2 PZ3.0*2 PZ4.0*1
Dr #2 #3 #4 #5 ⊖ Y0.8*2 Y2.0*2 Y2.5*2 Y3.0*2

Accessories:

Big suction cup with key ring*1
Double-end spudger*1
Thin triangular slice*6
Soft extension bar*1
Extension bar*1
Magnetizer*1
Tweezers*1
Spudger*1
Manual*1
Brush*1
Handle*1

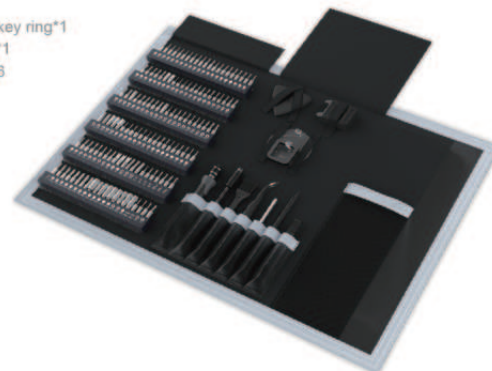

YF-P14

Precision screwdriver

145PCS

Sockets:

M2.5*2 M3.0 M3.5 M4.0 M4.5 M5.0 M5.5 G3.8 G4.5 PH2 0

H4*28MM:

● H0.7 H0.9 H1.3 H1.5 H2.0 H2.5 H3.0 H3.5 H4.0 H4.5 H5.0 H6.0 ⓐ 2.0 2.3 2.6 3.0

Ⓢ 1.0*2 1.5*3 2.0*2 2.5*2 3.0*3 3.5*2 JIS000 JIS00 JIS0 JIS1 ● SQ0 SQ1 SQ2

● T1*3 T2*3 T3*2 T4*2 T5 T6 T7 T8 T9 T10 T15 T20 T6H T7H T8H T9H T10H
T15H T20H

⊖ 1.0*2 1.3*2 1.5*2 2.0*2 2.5*2 3.0*2 3.5*2 4.0*2 ● SIM0.8 SIM1.0

⊖ Y0.8*3 Y2.0*2 Y2.5*2 Y3.0*2 ● U2.0*2 U2.6*2 U3.0*2 ● 1.5*2

⊖ P200*2 P20*2 PZ1*2 PZ2*2 ⓐ 0.8*3 1.2*3 1.5*3 2.0*2

H4*45MM:

⊖ 1.5 2.0

⊖ 1.5 2.0

Accessories:

Soft extension bar*1

Aluminum alloy handle*1

Accessories box*1

Plastic spudger*2

Opening tool*5

Magnetizer*1

Suction up*1

Tweezer*1



JM-8183

Aluminum alloy screwdriver

⊖ Y0.6

● 1.5

● T2

⊖ 1.5

● 0.8



JM-8179

Precision screwdriver

26PCS

H4*28MM:

● T1 T2 T3 T4 T5 T6H T7H ● H1.3 H1.5 H2.0

Ⓢ 1.0 1.5 2.0 ⊖ 1.5 2.0 2.5

● 0.8 1.2 2.0 ⊖ Y0.8 Y2.5

⊖ U2.6 ⓐ 2.0 ● 1.5

Accessories:

Magnetizer*1

Handle*1



JM-8178

Professional & precision screwdriver tool set

106PCS

Sockets:

M2.5 M3.0 M3.5 M4.0 M4.5 M5.0 M5.5 G3.8 G4.5

H4*28MM:

● H0.7 H0.9 H1.3 H1.5 H2.0 H2.5 H3.0 H3.5 H4.0 H4.5 H5.0 H6.0 ● SIM0.8 SIM1.0

● T1 T2*2 T3*2 T4*2 T5*2 T6 T7 T8 T9 T10 T15 T20 T6H T7H T8H T9H

T10H T15H T20H

Ⓢ 1.0*2 1.5*2 2.0*2 2.5*2 4.0*2 ⊖ U2.6*2 U3.0*2 ⊖ Y0.8*2 Y2.0*2 Y2.5*2 Y3.0

⊖ 1.0*2 1.3*2 1.5*2 2.0*2 2.5*2 3.0*2 3.5*2 4.0 ● 0.8*2 1.2*2 1.5*2 2.0

● PZ1.0 PZ2.0 PZ3.0 PZ4.0 ⓐ 2.0 2.3 2.6 3.0 ● SQ0 SQ1 SQ2 ● 1.5*2

Accessories:

Soft extension bar*1

Magnetizer*1

Tweezers*1

Handle*1



JM-8177

Professional & precision screwdriver tool set

106PCS

Sockets:

M2.5 M3.0 M3.5 M4.0 M4.5 M5.0 M5.5 G3.8 G4.5

H4*28MM:

● H0.7 H0.9 H1.3 H1.5 H2.0 H2.5 H3.0 H3.5 H4.0 H4.5 H5.0 H6.0 ● SIM0.8 SIM1.0
 ● T1 T2*2 T3*2 T4*2 T5*2 T6 T7 T8 T9 T10 T15 T20 T6H T7H T8H T9H
 T10H T15H T20H
 ⊕ 1.0*2 1.5*2 2.0*2 2.5*2 4.0*2 ⊖ U2.6*2 U3.0*2 ⊙ Y0.8*2 Y2.0*2 Y2.5*2 Y3.0
 ⊖ 1.0*2 1.3*2 1.5*2 2.0*2 2.5*2 3.0*2 3.5*2 4.0 ● 0.8*2 1.2*2 1.5*2 2.0
 ● PZ1.0 PZ2.0 PZ3.0 PZ4.0 ⊕ 2.0 2.3 2.6 3.0 ● SQ0 SQ1 SQ2 ● 1.5*2

Accessories:

Soft extension bar*1
 Extension bar*1
 Magnetizer*1
 Tweezers*1
 Handle*1



JM-8176

Multifunctional precision screwdriver

50PCS

H4*28MM:

● T2 T3 T4 T5 T6H T7H T8H T9H T10H T15H T20H
 ● H0.7 H0.9 H1.3 H1.5 H2.0 H2.5 H3.0 H3.5 H4.0
 ⊕ 1.0 1.5 2.0 2.5 3.0 3.5 ● SQ0 SQ1 SQ2
 ⊖ 1.0 1.5 2.0 2.5 3.0 3.5 ⊕ 2.0 2.3 3.0
 ⊙ Y0.8 Y2.0 Y2.5 Y3.0 ⊖ U2.6
 ● 0.8 1.2 1.5 2.0 ● 1.5

Accessories:

Soft extension bar*1
 Handle*1



JM-8175

Pro tech screwdriver set

45PCS

H4*28MM:

● T2 T3 T4 T5 T6H T7H T8H T9H T10H ● 0.8 1.2 1.5 2.0 ● 1.5
 ⊕ 1.0 1.5 2.0 2.5 ⊖ 1.0 1.5 2.0 2.5 ⊙ Y0.8 Y2.0 ⊕ 2.3

H6.3*25MM:

● T15H T20H T25H T27H T30H ⊕ 3.0 4.0 5.0 ● PZ0 PZ1.0
 ● H2.0 H2.5 H3.0 H4.0 ⊖ 3.0 4.0 5.0

Accessories:

H6.3 transfer to H4.0 Connector*1
 H4.0 transfer to H6.3 Connector*1
 Handle*1 Felt bag*1



JM-8174

Pro tech screwdriver set

69PCS

Sockets:

M2.5 M3.0 M3.5 M4.0 M4.5 M5.0 M5.5 G3.8 G4.5

H4*28MM:

● H0.9 H1.3 H1.5 H2.0 H2.5 H3.0 H3.5 H4.0 H4.5 H5.0 H6.0 ● SQ0 SQ1 SQ2
 ● T2 T3 T4 T5 T6H T7H T8H T9H T10H T15H T20H ⊙ Y0.8 Y2.0 Y2.5 Y3.0
 ⊖ 1.0 1.5 2.0 2.5 3.0 3.5 ⊕ 1.0 1.5 2.0 2.5 3.0 3.5 ● 1.5
 ● 0.8 1.2 1.5 2.0 ⊕ 2.0 2.3

Accessories:

Double-head heads flexible opening tool*1
 H6.3 transfer to H4.0 Connector*1
 H4.0 transfer to H6.3 Connector*1
 30° Art and craft knife*2
 Thin triangular slice*3
 Opening tool*2
 Magnetizer*1
 Tweezers*1
 Handle*1



JM-8173

Pro tech screwdriver set

73PCS

Sockets:

M2.5 M3.0 M3.5 M4.0 M4.5 M5.0 M5.5 G3.8 G4.5

H4*28MM:

⊕ H0.9 H1.3 H1.5 H2.0 H2.5 H3.0 H3.5 H4.0 H4.5 H5.0 H6.0 ⊕ SQ0 SQ1 SQ2

⊕ T2 T3 T4 T5 T6H T7H T8H T9H T10H T15H T20H ⊖ Y0.8 Y2.0 Y2.5 Y3.0

⊖ 1.0 1.5 2.0 2.5 3.0 3.5 ⊕ 1.0 1.5 2.0 2.5 3.0 3.5 ⊕ 1.5

⊕ 0.8 1.2 1.5 2.0 ⊕ 2.0 2.3

H4*45MM:

⊕ 2.5 3.5 ⊖ 2.0 ⊕ U2.6 ⊖ Y2.5 ⊕ 2.3 ⊕ T10H

Accessories:

Big suction cup with key ring*1

Soft extension bar*1

Thin triangular slice*3

Opening tool*2

Tweezers*1

Handle*1



JM-8172

Portable DIY electronic maintenance magic box kit

17PCS

H4*28MM:

⊕ T2 T3 T4 T5 T6H T7H T8H

⊖ 1.5 2.0 2.5 3.0

⊕ 1.5 2.0 2.5 3.0

⊖ Y0.8 Y2.5

⊕ 0.8 1.2

⊕ 1.5

Accessories:

Handle*1



JM-8171

Portable DIY electronic maintenance magic box kit

21PCS

H4*28MM:

⊕ T2 T3 T4 T5 T6H T7H T8H

⊖ 1.5 2.0 2.5 3.0

⊕ 1.5 2.0 2.5 3.0

⊖ Y0.8 Y2.5

⊕ 0.8 1.2

⊕ 1.5

Accessories:

Handle*1



JM-8170

Portable precision screwdriver set

61PCS

Sockets:

M2.5 M3.0 M3.5 M4.0 M4.5 M5.0

H4*28MM:

⊕ T3 T4 T5 T6H T7H T8H T9H T10H T15H T20H ⊕ SQ0 SQ1 SQ2 ⊕ 2.3

⊕ H0.9 H1.3 H1.5 H2.0 H2.5 H3.0 H3.5 H4.0 ⊕ U2.6 ⊖ Y2 Y3

⊕ 1.0 1.5 2.0 2.5 3.5 J000 J00 J0 J1 ⊕ 0.8 1.2 1.5 2.0

⊖ 1.0 1.5 2.0 2.5 3.0 3.5 4.0 ⊖ Y0.8 ⊕ T2

⊕ H4.5 H5.0 H6.0 ⊕ 1.5

Accessories:

H6.3 transfer connector*1

Soft extension bar*1

H4 connector*1

Handle*1



JM-8166

Comprehensive DIY electronics maintenance tools

62PCS

Sockets:

M2.5 M3.0 M3.5 M4.0 M4.5 M5.0

H4*28MM:

⊙ H0.9 H1.3 H1.5 H2.0 H2.5 H3.0 H3.5 H4.0 H4.5 H5.0 H6.0

⊙ T2 T3 T4 T5 T6H T7H T8H T9H T10H T15H T20H

⊕ 1.0 1.5 2.0 2.5 3.0 3.5 4.0 ⊕ 2.0 2.3 3.0 ⊗ 1.5

⊕ 1.0 1.5 2.0 2.5 3.0 3.5 ⊗ 0.8 1.2 1.5 2.0

⊙ Y0.8 Y2.0 Y2.5 Y3.0 ⊕ U2.6

Accessories:

H6.3 transfer to H4.0 Connector*1

H4.0 transfer to H6.3 Connector*1

Flexible extension bar*4

Double-end opening tool*2

Precision spudger*1

Tweezers*1

Handle*1



JM-8163



Precision screwdriver set & socket set

33PCS

Sockets:

M2.5 M3.0 M3.5 M4.0 M4.5

H4*28MM:

⊙ H2.0 H3.0 ⊕ T3 T4 T5 T6H T7H T8H T9H T10H ⊖ 1.0 2.0 3.0

⊕ 1.5 2.5 3.5 ⊕ 0.8 1.2 ⊙ Y0.8 ⊗ 1.5

Threaded screwdriver:

#2 #3 #4 #5

Accessories:

Flexible extension bar*1

Extension bar*1

Tweezers*1

Handle*1



JM-8160



Precision screwdriver set & socket set

34PCS

H4*28MM:

⊙ T3 T4 T5 T6H T7H T8H T9H T10H

⊙ H0.9 H1.5 H2.0 H3.0

⊕ 1.0 1.5 2.0 3.5

⊖ 1.0 1.5 2.0 3.0

⊙ Y0.8 ⊗ 0.8 1.2

⊕ U2.6 ⊕ 2.3

⊗ 1.5

Threaded screwdriver:

#2 #3 #4 #5

Accessories:

Flexible extension bar*1

Tweezers*1

Handle*1



JM-8159



Hex screwdriver set for model/toy/hobby

6PCS

⊙ H1.5 H2.0 H2.5 H3.0

⊕ 3.0



JM-8154



Aluminium alloy handle DIY repair tool kit

38PCS

H4*28MM:

- ⊙ H0.9 H1.3 H1.5 H2.0 H2.5 H3.0 H3.5 H4.0 ⊙ Y2.0
- ⊙ T3 T4 T5 T6H T7H T8H T9H T10H T15H T20H
- ⊙ 1.0 1.5 2.0 2.5 3.0 3.5 4.0 ⊕ 2.3 ⊕ 0.8 1.2
- ⊕ 1.0 1.5 2.0 2.5 3.5 ⊙ 0.8 SMPH ⊕ U2.6

Accessories:

- Extension bar*1
- Handle*1



JM-8151



Anti-slip precision screwdriver

- ⊙ T2 T3 T4 T5 T6
- ⊕ 1.5 2.0
- ⊙ 2.5
- ⊙ Y0.8
- ⊙ 0.8 1.2
- ⊙ 1.5



JM-8147



Household DIY maintenance toolkit

47PCS

Sockets:

- M2.5 M3.0 M3.5 M4.0 M4.5 M5.0

H4*45MM:

- ⊙ T2 T5 ⊙ 1.0 1.5 2.0
- ⊕ 1.0 1.5 2.5 ⊙ Y0.8
- ⊕ U2.6 ⊕ 0.8 1.2

H6.3*25MM:

- ⊙ H3.0 H4.0 H5.0 ⊕ T6 T7 T8H
- ⊙ 3.0 4.0 5.0 ⊙ Y2.0 Y3.0 ⊕ U6
- ⊕ 4.0 5.0 6.0 ⊕ Pz2 Pz3

Accessories:

- Tin scraper made of memory metal*1
- H6.3 transfer to H4.0 Connector*1
- H4 transfer to 1/4 connector*1
- Triangle opening tool*1
- Strong suction cup*1
- Ratchet handle*1
- Diagonal plier*1
- Extension bar*1
- SIM card pin*1
- Tweezers*1
- 30° Knife*1
- Crowbar*1
- Handle*1



JM-8146



Antic drop electronic toolkit

47PCS

H4*28MM:

- ⊙ T3 T4 T5 T6H T7H T8H T9H T10H T15H T20H
- ⊙ H1.3 H1.5 H2.0 H3.0 H4.0 H5.0
- ⊙ 1.5 2.0 2.5 3.0 3.5
- ⊕ 1.0 1.5 2.0 2.5 3.5
- ⊙ Y2.0 ⊕ U2.6
- ⊙ 0.8 1.2 ⊕ 2.0

Accessories:

- Components storage box*1 (including 2PCS PH2.5 sockets)
- Handle*2(⊕ 1.5 ⊕ 0.8)
- 30° art and craft knife*1
- Roller opening tool*1
- Metal spudger*1
- Extension bar*1
- Opening tool*1
- SIM card pin*1
- Suction cup*1
- Tweezers*1



JM-8139



Deep hole working electronics repair toolkit

H4*45MM:

- ⊕ T2 T4 T5 T8H T10H
- ⊕ 1.0 1.5 2.5 3.5
- ⊖ 1.0 1.5 2.0
- H3.0 H4.0
- Y0.8 Y2.5
- ⊕ 0.8 1.2
- Ⓜ U2.6
- Ⓜ 2.3

Accessories:

- Soft extension bar*1
- Tweezers*1
- Handle*1



JM-8133

23PCS



Professional screwdriver set

Sockets:

M2.5 M3.0 M3.5 M4.0 M4.5 M5.0 M5.5

H4*28MM:

- ⊕ T3 T4 T5 T6H T7H T8H T9H T10H T15H T20H
- H0.9 H1.3 H1.5 H2.0 H2.5 H3.0 H3.5 H4.0
- ⊖ 1.0 1.5 2.0 2.5 3.0 3.5 4.0
- ⊕ 1.0 1.5 2.0 2.5 3.5
- ⊕ 0.8 ○ Y2.0 Ⓜ 2.0
- Ⓜ U2.6 ● 0.8

Accessories:

- Soft extension bar*1
- Extension bar*1
- Handle*1



JM-8130

45PCS



Professional screwdriver set

Sockets:

M2.5 M3.0 M3.5 M4.0 M4.5 M5.0 M5.5

H4*28MM:

- ⊕ T3 T4 T5 T6H T7H T8H T9H T10H T15H T20H
- H0.9 H1.3 H1.5 H2.0 H2.5 H3.0 H3.5 H4.0
- ⊖ 1.0 1.5 2.0 2.5 3.0 3.5 4.0
- ⊕ 1.0 1.5 2.0 2.5 3.5
- ⊕ 0.8 ○ Y2.0 Ⓜ 2.0
- Ⓜ U2.6 ● 0.8

Accessories:

- Soft extension bar*1
- Tweezers*1
- Handle*1



JM-8129

45PCS



Professional screwdriver set

Sockets:

M2.5 M3.0 M3.5 M4.0 M4.5 M5.0 M5.5

H4*28MM:

- ⊕ T3 T4 T5 T6H T7H T8H T9H T10H T15H T20H
- H0.9 H1.3 H1.5 H2.0 H2.5 H3.0 H3.5 H4.0
- ⊖ 1.0 1.5 2.0 2.5 3.0 3.5 4.0
- ⊕ 1.0 1.5 2.0 2.5 3.5
- ⊕ 0.8 ○ Y2.0 Ⓜ 2.0
- Ⓜ U2.6 ● 0.8

Accessories:

- Extension bar*1
- Tweezers*1
- Handle*1



JM-8128

45PCS



Professional screwdriver set

58PCS

Sockets:

M2.5 M3.0 M3.5 M4.0 M4.5 M5.0

H4*28MM:

● H0.9 H1.3 H1.5 H2.0 H2.5 H3.0 H3.5 H4.0 H4.5 H5.0 H6.0
 ● T3 T4 T5 T6H T7H T8H T9H T10H T15H T20H ● 1.5
 ⊕ 1.0 1.5 2.0 2.5 3.5 J000 J00 J0 J1 ⊖ Y0.8 Y2.0 Y3.0
 ⊖ 1.0 1.5 2.0 2.5 3.0 3.5 4.0 ● SQ0 SQ1 SQ2
 ● 0.8 1.2 1.5 2.0 ⊕ 2.3 ⊖ U2.6

Accessories:

H6.3 transfer to H4.0 Connector*1
 138 Handle with magnetic*1
 Soft extension bar*1
 Extension bar*1
 Handle*1



JM-8126

Precision screwdriver toolkit

58PCS

Sockets:

M2.5 M3.0 M3.5 M4.0 M4.5 M5.0

H4*28MM:

● H0.9 H1.3 H1.5 H2.0 H2.5 H3.0 H3.5 H4.0 H4.5 H5.0 H6.0 ● SQ0 SQ1 SQ2
 ● T3 T4 T5 T6 T7 T8 T9 T10 T15 T20 ⊕ 1.0 1.5 2.0 2.5 3.5 J000 J00 J0 J1
 ⊖ 1.0 1.5 2.0 2.5 3.0 3.5 4.0 ⊕ 2.3 ⊖ Y2.0 Y3.0 ⊖ U2.6 ● 0.8 1.2 1.5 2.0

Accessories:

H6.3 transfer to H4.0 Connector*1
 Soft extension bar*1
 Extension bar*1
 Handle*1



JM-8125

Electronic maintenance single screwdriver

⊕ 1.2 1.5 2.0 2.5
 ⊖ 1.5 2.0 2.5
 ● 0.8 1.2 1.5
 ● T4 T5 T6



JM-8119

Professional precision screwdriver set

45PCS

Sockets:

M2.5 M3.0 M3.5 M4.0 M4.5 M5.0 M5.5

H4*28MM:

● T3 T4 T5 T6H T7H T8H T9H T10H T15H T20H
 ● H0.9 H1.3 H1.5 H2.0 H2.5 H3.0 H4.0
 ⊖ 1.0 1.5 2.0 2.5 3.0 3.5 4.0 ● 0.8
 ⊕ 1.0 1.5 2.0 2.5 3.0 3.5 ⊖ U2.6
 ● 2.0 ⊖ Y2.0 ● 0.8

Accessories:

Multipoint adjustable bar*1
 Extension bar*1
 Handle*1



JM-8116

Precision screwdriver toolkit various bits

33PCS

H4*28MM:

- ⊙ T3 T4 T5 T6H T7H T8H T9H T10H T15H T20H
- ⊙ H1.3 H1.5 H2.0 H2.5 H3.0 H4.0
- ⊖ 1.5 2.0 2.5 3.0 3.5 ⊖ Y2.0
- ⊕ 1.5 2.0 2.5 3.0 3.5 ⊕ 0.8
- ⊕ 2.0 ⊕ U2.6

Accessories:

- Extension bar*1
- Tweezers*1
- Handle*1



JM-8101



Precision screwdriver toolkit various bits

32PCS

H4*28MM:

- ⊙ T3 T4 T5 T6H T7H T8H T9H T10H T15H T20H
- ⊙ H1.3 H1.5 H2.0 H2.5 H3.0 H4.0
- ⊖ 1.5 2.0 2.5 3.0 3.5 ⊖ Y2.0
- ⊕ 1.5 2.0 2.5 3.0 3.5 ⊕ 0.8
- ⊕ 2.0 ⊕ U2.6

Accessories:

- Tweezers*1
- Handle*1



JM-8100



High-end home improvement screwdriver set

60PCS

Socket:

- M5.0 M6.0 M7.0 M8.0 M9.0 M10 M11 M12 M13

Matte chrome bits H4*28mm:

- ⊙ T2 T3 T4 T5 ⊙ H1.3 H1.5 H2.0 H2.5 ⊖ Y8 Y2.5 ⊕ 0.8 1.2 ⊕ 1.5
- ⊕ 1.0 1.5 2.0 2.5 ⊖ 1.0 1.5 2.0 2.5 ⊕ U2.6

H6.3*25mm:

- ⊙ T7H T8H T9H T10H T15H T20H T25H T27H T30H ⊕ 6.0 6.5
- ⊖ 3.0 6.0 7.0 ⊕ H4.0 H5.0 ⊕ Pz1 Pz2 Pz3 ⊕ U6.0 ⊖ Y1

H6.3*45mm:

- ⊕ 4.0 5.0 ⊖ 4.5 5.0

Accessories:

- H6.3 transfer to H4.0 Connector*1
- Marble connector*1
- Multipoint adjustable bar*1
- Handle*1



JM-6125



Household tool set

48PCS

H6 3*25MM:

- ⊙ T4 T5 T6 T7 T8H T9H T10H T15H T20H T25H T27H T30H T40H
- ⊙ H2.0 H2.5 H3.0 H4.0 H5.0 H6.0
- ⊖ 2.0 2.5 3.0 4.0 5.0 6.0 7.0
- ⊖ 3.0 4.0 5.0 6.0 6.5
- ⊙ Pz0 Pz1 Pz2 Pz3
- ⊖ Y1.0 Y2.0 Y3.0
- ⊕ 2.0 2.3 3.0
- ⊕ U6 U8
- ⊙ R1 R2

Accessories:

- Multipoint adjustable bar*1
- Nail pryer*1
- Handle*1



JM-6124



Professional maintenance tool set

31PCS

Sockets 1/4*20MM:

M5.0 M6.0 M7.0 M8.0 M9.0 M10 M11 M12 M13

Bits with color ring H6.3*60MM:

⊕ T20 T25 ⊕ H5.0 H6.0 ⊖ SL1 SL2 ⊕ PH1 PH2 ⊕ Pz1 Pz2

H4*45MM:

⊖ 2.0 ⊕ 1.0 15 ⊕ T2 ⊕ 0.8 1.2

Accessories:

Spring flexible extension bar*1

Marble connector*1

Magnetizer area*1

Handle*1



JM-6123

Professional maintenance tool set

31PCS

Sockets 1/4*25MM:

M5.0 M6.0 M7.0 M8.0 M9.0 M10 M11 M12 M13

Bright chrome bits H6.3*60MM:

⊕ T20 T25 ⊖ 5.0 6.0 ⊕ 5.0 6.0 ⊕ H5.0 H6.0 ⊕ Pz1 Pz2

H4*45MM:

⊕ 1.0 1.5 ⊖ 2.0 ⊕ 0.8 1.2 ⊕ T2

Accessories:

Flexible extension bar*1

Marble connector*1

Magnetizer area*1

Medium handle*1

Extension bar*1

Big handle*1



JM-6121

Household repair toolkit

73PCS

Bright chrome bits H6.3*25MM:

⊕ T9H T10H T15H T20H T25H T30H ⊖ 3.0 4.0 5.0 6.0 7.0 ⊕ Pz1 Pz2 Pz3

⊕ H2.5 H3.0 H4.0 H5.0 H6.0 ⊕ 4.0 5.0 6.0 6.5 ⊕ 2.3 ⊕ R1

⊖ Y1 Y2 Y3 ⊕ U6 U8

H4*28MM:

⊕ H0.9 H1.3 H1.5 H2.0 H2.5 H3.0 H3.5 H4.0
H4.5 H5.0 H6.0

⊕ T3 T4 T5 T6 T7 T8 T9 T10 T15 T20

⊕ 1.0 1.5 2.0 2.5 3.5 ⊕ 2.0 2.3

⊖ 1.0 1.5 2.0 2.5 3.0 3.5 4.0

⊕ 0.8 ⊖ Y2.0 ⊕ U2.6

Accessories:

Medium extension bar*1

Soft extension bar*1

Big extension bar*1

Medium handle*1

Big handle*1



JM-6113

Telecom ratchet screwdriver toolkit

69PCS

Sockets:

M5.0 M6.0 M7.0 M8.0 M9.0 M10 M11 M12 M13

Bright chrome bits H6.3*25MM:

⊕ T4 T5 T6H T7H T8H T9H T10H T15H T20H T25H T30H ⊖ Y1.0

⊕ H2.5 H3.0 H4.0 H5.0 H6.0 ⊖ 3.0 4.0 5.0 6.0 7.0 ⊖ R1

⊕ 4.0 5.0 6.0 6.5 ⊕ U6 ⊕ 2.3 ⊕ Pz1 Pz2 Pz3

H4*28MM:

⊕ T3 T4 T5 T6H T7H T8H T9H T10H T15H T20H

⊖ 1.5 2.0 2.5 3.0 3.5 ⊕ 3.0

⊕ 2.0 2.5 3.0 3.5

⊕ H2.5 H3.0 H4.0

Accessories:

Soft extension bar*1

Marble connector*1

Extension bar*1

Medium handle*1

Big handle*1



JM-6111

6 inches Clamping Tools

45# Carbon Steel



JM-CT1 Series

8 inches Clamping Tools

45# Carbon Steel



JM-CT1 Series

American Style Clamping Tools

45# Nickel Alloy



18

JM-CT2 Series

▶ **CT1 Series Long nose pliers**
Made of high-quality steel, with long and hardened jaw, used for wire stripping.



▶ **CT1 Series Diagonal pliers**
With wide and hardened jaw, labor-saving.



▶ **CT1 Series Flat nose pliers**
Made of high-quality steel, with long and hardened jaw, used for wire stripping.



▶ **CT2 Series American style long nose pliers**
Made of high-quality steel, with long and hardened jaw, used for wire stripping.



▶ **CT2 Series American style diagonal pliers**
With wide and hardened jaw, labor-saving.



Cold-rolled steel 08F



▶ CT4 Series Crimping Pliers

Used for wire crimping, stripping and trimming. Suitable for cutting two type wires (6P, 8P).



▶ CT4 Series Multifunctional Wire Stripper

Used for wire crimping, stripping and trimming. Suitable for cutting three type wires (4P, 6P, 8P). Equipped with wire stripping knife for wire stripping and clamping.



▶ CT4 Series Multifunctional Wire Stripper

Suitable for wires in 0.6 to 2.6 mm. Round hole design can protect wire from damage and make it easy to strip wires.



JM-CT4 Series

Professional D.I.Y Electronic Repair Tool Kit

74PCS

Accessories:

58 in 1 Screwdriver Set
Metal Spudgers*3
Anti-static Spudger*1
Anti-static Wrist Strap*1
Opening Stick*4
Stainless Tweezers*3
Metal Grabber*1
Powerful Suction Cup*1
Vernier Cursor*1
Cloth Bag*1
Paper Card



JM-P01

Multifunctional D.I.Y Repair Tool Set

74PCS

Accessories:

58 in 1 Screwdriver Set
Metal Spudgers*3
Anti-static Spudger*1
Anti-static Wrist Strap*1
Opening Stick*4
Stainless Tweezers*3
Metal Grabber*1
Powerful Suction Cup*1
Vernier Cursor*1
Cloth Bag*1
Paper Card



JM-P03

Professional Repair Tool kit

54PCS

Accessories:

- 1.Aluminium Alloy Screwdriver Set
- 2.Plastic Opening Stick
- 3.Plastic Opening Pick
- 4.Stainless Steel Scraping Knife
- 5.Anti-static Tweezers
- 6.Roller Opening Tool
- 7.Anti-static Wrist Strap
- 8.Cleaning Cloth
- 9.Erasable Marker
- 10.Extension Bar
- 11.Suction Cup
- 12.Magnetic Working Mat
- 13.Metal Spudger



JM-P13

Network Repair Tool Set

17PCS

Accessories:

- 1.Wire Stripper
- 2.Long Nose Pliers
- 3.Crimping Pliers
- 4.Diagonal Pliers
- 5.6P 8P Registered Jack
- 6.PH2 Screwdriver
- 7.SL2 Screwdriver
- 8.Electroprobe
- 9.Electric Soldering Iron
- 10.Insulating Tape
- 11.Battery (9V)
- 12.Solder Wire
- 13.Punch Down Tool
- 14.Simple Punch Down Tool
- 15.Multimeter
- 16.Network Tester
- 17.Curved Tweezers



JM-P15

Cube Shaped Magnetizer

#Magnetization

#Demagnetization

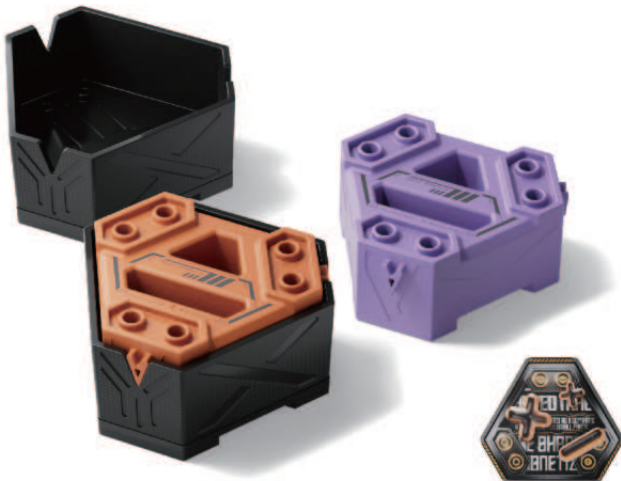

JM-Z21

Professional Solder Assist Tool

6PCS

Accessories:

- 1.Hook
- 2.Fork
- 3.Crotchet
- 4.Sharpness
- 5.Knife
- 6.Broom

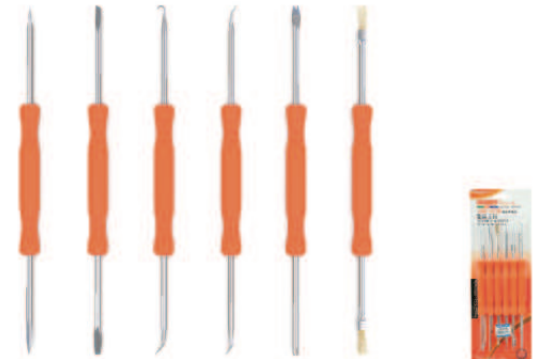

JM-Z01

3 IN 1 Magnetic Operating Mat

Features:

Magnetized to hold small screws securely.
Correctable surface keeps notes and stops mistakes.
Reduces reassemble time by up to 40%.

Accessories:

- 1.Magnetic Working Mat
- 2.Mark Pen
- 3.Eraser



JM-Z09

3PCS

4 IN 1 Smart Phone Repair Holder

Features:

High quality steel makes it durable. Paint spraying make it good rust resistance.

Application: Disassembling and prying.

This product is a patent product.

Closed holder's usage as the mobile phone adjusted PCB holder.

Open the holder and then adjust the angle with the side spiral according to your repairing needs. Maximum size is for 5.5 inches cell phones and push the buckles up and down to fixing the disassembled cell phone.

Accessories:

Screwdriver Type

- ⊕ 1.5
- ⊖ 2.0
- ⊕ 0.8

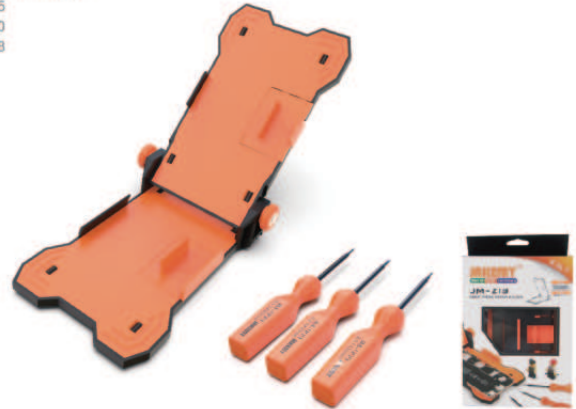

JM-Z13

4PCS

Accessories Box

Features:

Fashionable, small and portable. The switch with slide fastener is sturdy, safe and convenient. The grids in the accessories box can be dismantled and assemble by yourself.



JM-Z14

PCB Holder Series



JM-Z15

Anti-static and Heat-proof Working Mat

Features:

Made of silicone which meet the American FDA standard with high temperature resistance.
Individual grid section can keep different components.
Applicable to all the electronic maintenance and repair workshop.
Can be used with magnetic mat to store and mark the screws or parts easily.



JM-Z16



Anti-static and Heat-proof Working Mat

Features:

Made of silicone which meet the American FDA standard with high temperature resistance.
Individual grip section can place different components.
Applicable to all the electronic maintenance and repair workshop.
The magnetic mat can store the parts safely and easily.



JM-Z17



8X Optical Magnifier

Features:

With two imported CREE LED lamps.
It's workable even in dark environment.
Large diameter lens makes it more clear and convenient to observe.
The handle's end part is round-shaped, with small holes in butterfly shape which is beautiful and can increase the frictional force. Application:
Digital product repair, education and instrument evaluation, printing industry, home living and machinery industry.



JM-Z19



Multipurpose Components Storage Box

Features:

Made of PP plastic.
Dismountable inner lining with different sizes can meet all your storage needs.
With double-layer design, you can make full use of space.



22

JM-Z20



LCD Screen Opening Pliers

Features:

Patented product.
Ergonomically designed handle with non-slip texture grip for comfortable hold.
Adjustable tablet holder to any size of tablets and mobiles.
Multiple angle PVC suction cup, easier to take apart every gadgets you want.



JM-OP05



3 In 1 Metal Spudger Set

Features:

More durable with special alloy steel material.
Easy-grip handle with just the right length for comfortable use.
Multi-type head design for different appliances.

3PCS



JM-OP07



Roller Opening Tool

Features:

Common used in laptops, mobiles and tablets disassembling.
Special rolling-wheel design for opening.
Made of high quality stainless steel, durable



JM-OP06



Flexible Opening Tool

Features:

New imported memory material for repeat operation .
Slim design for disassembling mobile phones, tablet computers.



JM-OP08



LCD Screen Opening Pliers

Features:

Patented product.
Ergonomically designed handle with non-slip texture grip for comfortable hold.
Extra large suction cup with multi-angle design, can easily and safely open over 4.7 inches of phones and tablets. Original pulling screw-thread design, the suction power is up to 60%.



JM-OP10

10 IN 1 Anti-static Fiber Opening Tools

10PCS

Features:

The spudger is made of anti-static material which can efficiently protect electronic components from static. Best angle for prying, make your disassembling easier. The product is stable and durable after high pressure injection molding. Ergonomic design makes the grip more comfortable.



JM-OP11

Double-head Heads Flexible Opening Tool

Features:

Patented design. Made of ingenious memory metal with good flexibility and resilience to protect electronic products from impactive damage. Protective cover for the security. With spatial mechanical characteristics, it can work speedy even in the most difficult reaching place. (Ultrathin and flexible with 0.25mm thickness)



JM-OP12

Precision Anti-static Metal Crowbar

Features:

Made of high quality alloy steel.
Anti-static coating makes it more durable.
Suitable for disassembling phone, computer, gamepad and other electronics.



JM-OP13

LCD Screen Opening Tool Set

2PCS

Features:

Patent product.

Made of ingenious memory metal with good flexibility and resilience to protect electronic products from impactive damage. With spatial mechanical characteristics, it can work rapidly even in the most difficult reaching place.

Accessories:

- 1.Screen opening plier
- 2.Double-end opening tool



JM-OP14

Opening Tool Set

13PCS

Features:

High toughness and good flexibility.

Made of imported anti-static environmental-friendly POM with great toughness and hardness. Equipped with rolling opening tool (JM-OP06) and double-end metal opening tool (JM-OP12) that can help you disassemble items quickly.



JM-OP15

Fiber Opening Tool

6PCS

Features:

Made of imported anti-static environmental-friendly POM, with high toughness and abrasion resistance. The working part with mechanics design makes your repair job more convenient.



JM-OP16

Multifunctional Roller Screwdriver Tool

9PCS

Features:

With precision bright chrome bits and flexible roller opener.

Application: For iPhone 7 and above models disassembling.

Use *0.8 bit to remove the two screws on the bottom of the phone.

Use the heat gun to heat the edge of screen for opening. Use OP022

roller to inset the edge of screen for a round until the screen is dismantled.

Bright chrome bits H4*28mm:

⊙ Y0.8 ⊕ 0.8 ⊕ 1.5 ⊕ 1.5

Accessories:

- 1.OP021 Roller
- 2.OP022 Roller



JM-OP17

Curved Screen
Disassemble Blade

1PCS

Features:

- *Specially designed for 98% of curved screen phone
- *High toughness
- *Made of SUS301 high flexibility steel
- *Epoxy handle design
- *Appropriate size



JM-OP18

Thick Triangular Slice

Quadrangled Spudger



JM-OP10

Curved Spudger

Double-end Spudger



JM-OP11

Thin Triangular Slice



JM-OP12



JM-OP13



JM-OP14

Extension
Quadrangled
Spudger



JM-OP015

Small Shovel-shape
Spudger



JM-OP016

Curved Pointed
Spudger



JM-OP017

Straight Pointed
Spudger



JM-OP018

Orthogonal
Crowbar



JM-OP019

Large Shovel-shape
Spudger



JM-OP020

Straight Metal
Spudger



JM-OP01

Curved Metal
Spudger



JM-OP02

Pointed Metal Spudger



JM-OP03

Anti-Static Plastic Spudger



JM-OP04

Big suction cup with key ring



JM-SK01

Solder pen 15g



JM-SW01

Thermal conductive grease



JM-SW02

Soldering paste



JM-SW03

Solder sucker



JM-Z02

Simple Y-type soldering iron stand



JM-Z03

Tip cleaning sponge

Aluminium alloy
carving knife

Aluminium alloy
scraper

30° Art and craft
knife



JM-Z04

JM-Z05

JM-Z06

JM-Z07

Push type alcohol
bottle 120ml

Push type alcohol
bottle 180ml

Memory metal tin
scraping knife

Double-sided
plush glasses
cloth



JM-Z10

JM-Z11

JM-Z12

JM-CS05

Rubber dust blower



JM-CS11

Digital Multimeter



JM-832

Precision diamond file

5PCS



JM-FL1-1

Single screwdriver set

5PCS



JM-999

B series large-sized tool bag

Size: 36*25*23cm



JM-B01

B series medium-sized tool bag

Size: 35.5*21*17cm



JM-B02

B series small-sized tool bag

Size: 27*15*12cm



JM-B03

B series tool waist bag



JM-B04

Stainless steel magnetic connector



JM-TP-01

Cursor ruler



JM-R12

Anti-static wrist strap



JM-E01

Powerful LCD suction cup

Features:

Made with environmental PVC material. Fine seal-ability, oil proof, anti-corrosion and nondeformable.

Metal screw-thread axis with a ABS plastic handle. Pull and suction capacity has been improved to 60%.

Suitable for disassembling screens off mobiles and tablets.

3PCS



JM-SK04

Combined suction cup for iPhone 7

Features:

Working part is made of environmental protection PVC material which is not easily deformed.

The handle is made of ABS and TPE with high hardness and comfortable hand feeling.

When you opened the iPhone 7 screen the suction can be used as a holder to hold the disassembled part and making your repair job more convenient.



JM-SK05

Electric Soldering Iron

Power:
SL01 30W
SL02 40W
SL04 60W



JM-SL0 Series

Mini Size Magnetizer and Demagnetizer



JM-X1

Mini Size Magnetizer and Demagnetizer



JM-X2

Large Size Magnetizer and Demagnetizer



JM-X3

Components Adsorption Bracelet

Features:

Lock catch design.
Good looking and easy to use.
The band of the bracelet can be adjusted according to different wrist size.
It can be used to magnetize and adsorb small components.



JM-X4



Magnetic Wristband

Features:

Made of 420 D oxford fabric.
Velcro design can fit all the size of wrist.
Suitable for home improvement for gathering screws, nails and drill bits.



JM-X5



Component Grabber

Material:

Precision Cast Steel

Features:

Apply to home improvement and outdoor infrastructure.
Ultra-precision processing which can make it not easy to damage.
The tiny components will not easy to fall off with four claws when gripping.
With strong magnetic that can adsorb small screws and nails in certain areas.

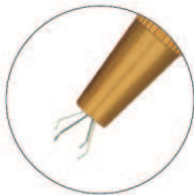

JM-T8-11



Replaceable Anti-static Tweezers Set

7PCS

Accessories:

Curved tweezers
Pointed tweezers
Replaceable screws
Stainless steel handle

Features:

The active part of the tweezers is made of carbon fiber with the features of high hardness and anti-static.
The tweezers' head is replaceable according to demand.



JM-T10-11



Replaceable Anti-static Flexible Tweezers Set

7PCS

Accessories:

Curved tweezer
Pointed tweezer
Replaceable tweezers
Stainless steel handle

Features:

The active part of the tweezers is made of carbon fiber with the features of high hardness, anti-static and flexible.
The tweezer head is replaceable according to demand.



JM-T10-12



Efficient Anti-static Tweezers Set

3PCS

Features:

The product is made of carbon fiber with the features of high hardness, anti-static and high temperature resistant.



JM-T11



Tweezers series

Tweezers are made of SUS201
HRC 35~40°C

Tweezers are made of SUS201
HRC 35~40°C

T2 Series ▶

T7 Series ▶



Black plated surface
The thickness of tweezers is 1.4mm



Black plated surface
The thickness of tweezers is 1.8mm
Hardened head

▶ 11 Series Long Nose Tweezers

The tweezer's tip is longer than standard length and it's suitable for operating precision parts



▶ 12 Series Short Pointed Tweezers

The tweezer's tip is harder than standard tweezer. The tweezer tip will not warp when clipping precision part.



▶ 13 Series Flat Tweezers

The tweezer's tip is round that it can protect parts from damage. It's suitable for picking up chips.



▶ 14 Series Pointed Tweezers

The tweezer's tip is very sharp and it's well for operating high intensity integrated circuit's parts.



▶ 15 Series Curved Tweezers

It's suitable for picking up parts of high intensity integrated circuit in narrow place.



Use of the bits:

 Phillips	+2.0mm	Macbook Pro Battery, Macbook Pro, Macbook Pro Trackpad, Macbook Pro Keyboard, Macbook Pro Assembly, etc.
	+1.5mm	For iPhone4/4s/5/5s/6/6s/6p/6s PLUS/7/7p/8/8p/x/xs/xr, Macbook Pro Retina Trackpad, Macbook Pro Retina/Macbook Air Keyboard, etc.
	+1.0 to 5.0mm	Phillips"+": 1.0mm, 1.5mm, 2.0mm, 2.5mm, 3.0mm, 4.0mm, 5.0mm for the disassembly of Samsung mobile phones and other mainstream mobile phones, a number of fine small household appliances, toys, watches, glasses, etc.
 Flat-head	-1.0 to 5.0mm	Flat-head"-": 1.0mm, 1.5mm, 2.0mm, 2.5mm, 3.0mm, 4.0mm, 5.0mm for the disassembly of Samsung mobile phones and other mainstream mobile phones, a number of fine small household appliances, toys, watches, glasses, etc.
 Pentagon	☆0.8mm	0.8mm Pentalobe Screwdriver for iPhone4/4s/5/5s/6/6s/6p/6s PLUS/7/7p/8/8p/x/xs/xr.
	☆1.2mm	1.2mm Pentalobe Screwdriver for Macbook Pro Retina/Macbook Air Battery, Macbook Pro Retina/Macbook Air Trackpad, Macbook Pro Retina/Macbook Air Keyboard, Macbook Pro Retina/Macbook Air Assembly.
	☆1.5mm	1.5mm Pentalobe Screwdriver for 2009 MacBook Pro 15" Battery.
 Torx	T5	Torx T5 For Macbook Pro Retina/Macbook Air Battery, Macbook Pro Retina/Macbook Air Trackpad, Macbook Pro Retina/Macbook Air Keyboard, Macbook Pro Retina/Macbook Air Assembly, Motorola, Nokia, HTC series mobile phone etc.
	T3/T4/T6/T7/T9	Torx T3/T4/T6/T7/T9 For Macbook Pro Retina/Macbook Air Battery, Macbook Pro Retina/Macbook Air Trackpad, Macbook Pro Retina/Macbook Air Keyboard, Macbook Pro Retina/Macbook Air Assembly, Motorola, Nokia, HTC series mobile phone etc.
	T2	For Huawei Mate 7 & Mate8 and P7 P8 P9 P10PLUS
 Torx Security	T6R/T8R/T10R	Torx T6R/T8R:parts For Macbook Pro Retina/Macbook Air Assembly, XBOX 360 & Motorola mobile phones and Sony Ericsson mobile phone, T10R: Screwdriver for XBOX 360.
 Tri-wing	Y0.8mm	Tri-point 0.8mm Y Screwdriver for Apple Watch and iPhone 7 only
	Y2.5mm	Tri-point 2.5mm Y Screwdriver for Macbook A1278 Trackpad/Trackpad/Keyboard, GBA NDS DSL Dsi 3DS XL Wii PS4 Controller.
 U shaped	U1.7 U2.3 U2.6	U shaped Groove Type Screwdriver for The Bulls Socket & Other Repair Tool.
 Triangle	△2.0/2.3/3.0mm	Triangle Head Screwdriver Set for Fixing Toys Like Thomas Trackmaster Trains Tomy and Thomas Mini Trains etc.
 Stand off	1.5mm	1.5mm Pinhead Phillips Precision screwdriver for repair iPhone 5/5S/4/4S Apple Watch 1/2 Middle Plate 2.5.
 Hex socket	2.5 to 5.5mm	Socket 2.5 to 5.5mm Screwdriver for Computer, Glasses, Watches, drones with camera and Household. Socket Head M2.5 Hexagon Screwdriver for iPhone 6S Metal Middle Plate Motherboard Screws Open Repair Tool.
 Hex	0.9 to 6.0mm	Hex sizes 0.9~6.0mm Screwdriver for Computer, Glasses, Watches, drones with camera and Household.
 Gamebit	3.8/4.5mm	Gamebit 3.8/4.5 mm bit for SNES N64 GameCube Game Consoles + Genesis Master System Games..
 SIM ejector	0.8mm	Point 0.8mm for SIM CARD REMOVER EJECT PIN.

Contact Information:

National Operation Center Address: No.10 Huanzhen East Road, Yanbu, Dali Town, Nanhai District, Foshan City, Guangdong Province, China

Tel: +86 18011760130 Email: yifengjakemy@gzyftools.com

Official Website: www.jakemy.com

1688.com: <https://gcjakemy.1688.com/>

Alibaba.com: <https://jackly.en.alibaba.com/>

JAKEMY®

*All pictures shown are for illustration purpose only. Actual product may vary due to product enhancement.

*All product parameter and function are subject to change without notice.

*Yifeng company reserves the right to change the product specification and appearance without notice.